

Article number: 03506120

Description: Fluro Rod end GE 120FO-2RS

Measures

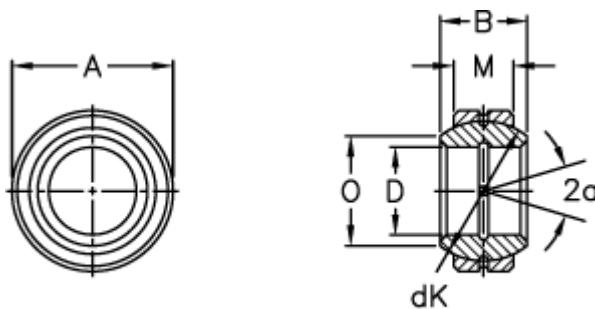

Str. 6-12 uden smørerille

A = 210 0 -0,030

B = 115

D = 120 0 -0,020

dK = 180

Dynamic load C (kN) = 1080

M = 70

O = 138.4

Static load C0 (kN) = 5400

Tilt angle = 16

Weight = 15100